

ASSEMBLY INSTRUCTION

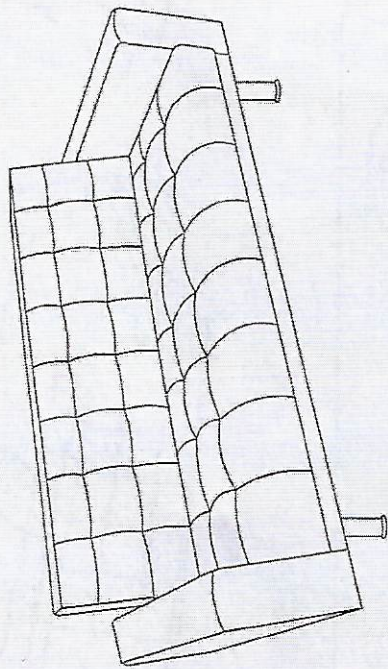

ASSEMBLY INSTRUCTIONS

Step1

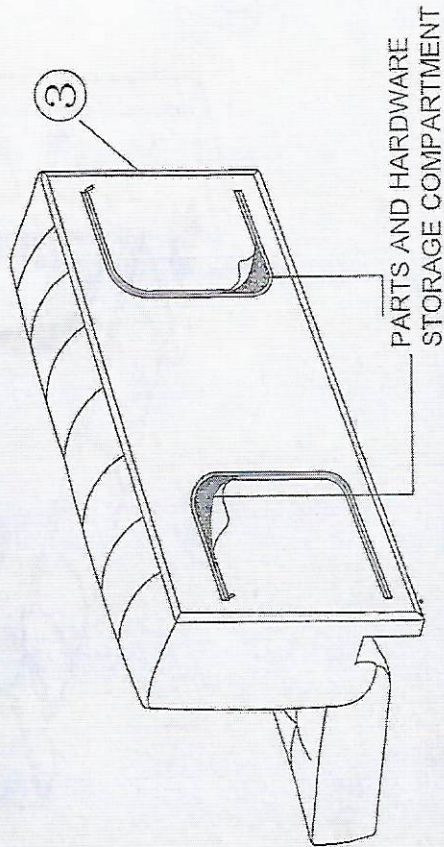

PARTS AND HARDWARE

Note: Individual parts are not shown to scale.



M14
A×1



M8
B×8



Ø8×2.2mm
C×8



Ø8×90mm
D×8

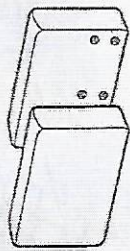

① 2pcs



② 4pcs

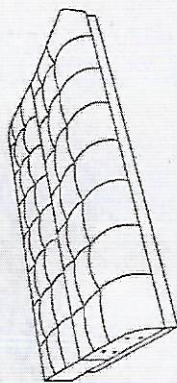

③ 1pcs

Step2

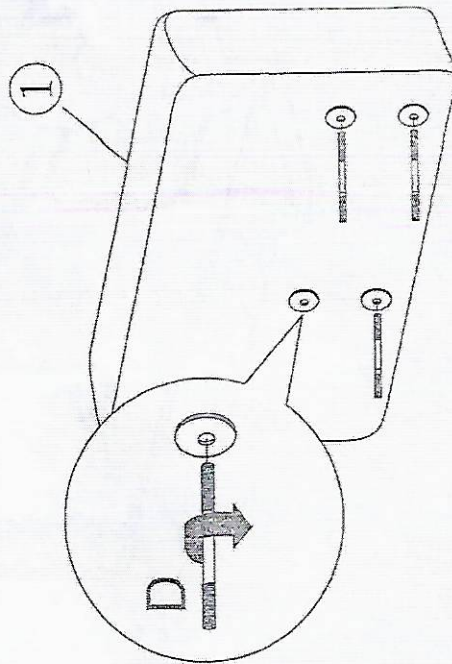

Step3

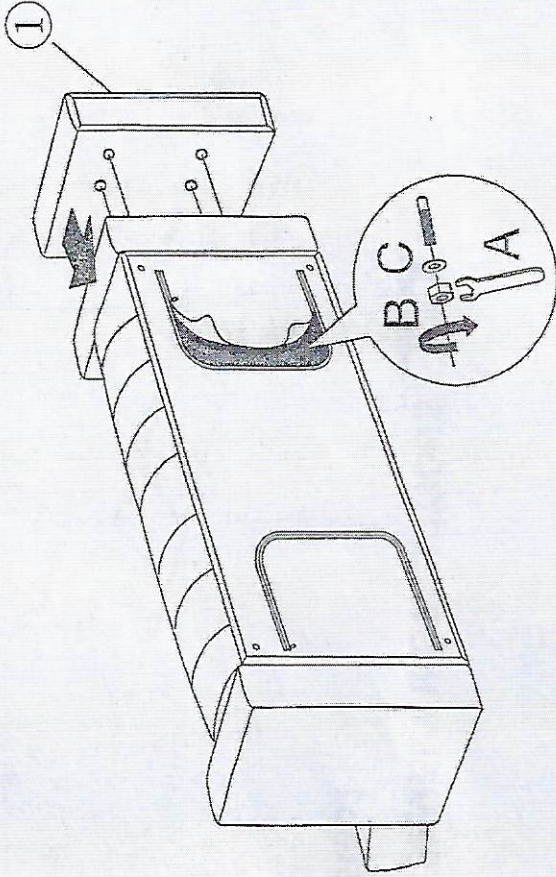

Step4

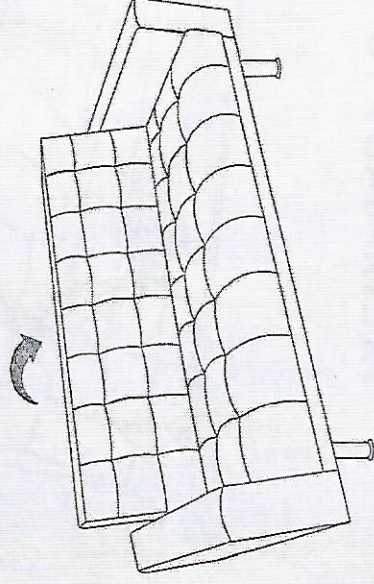
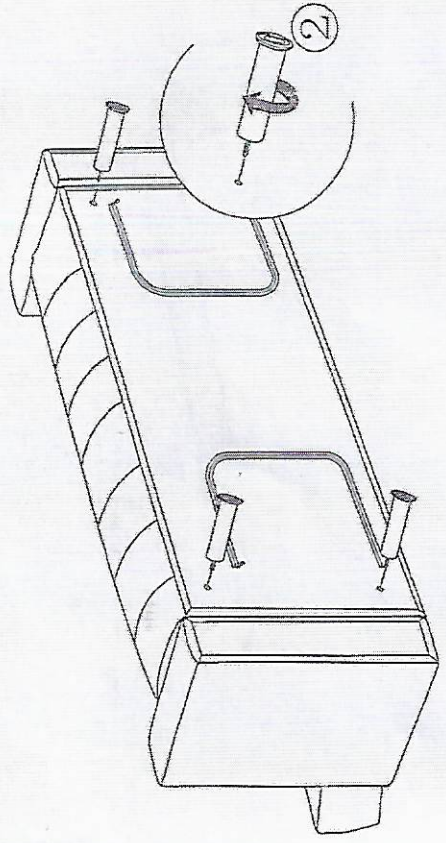

Sofa

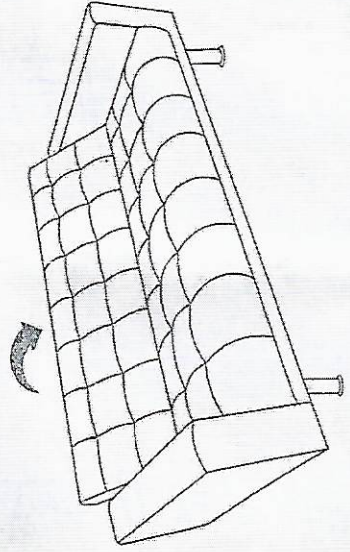

Lounger

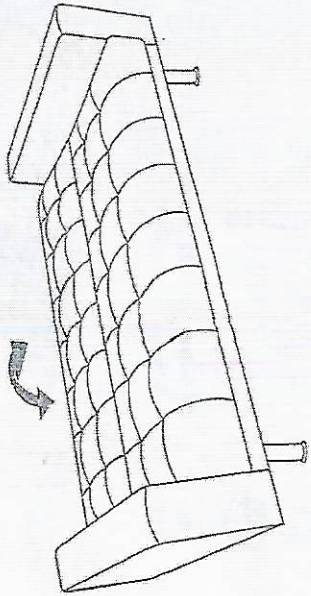

Bed