









ASSEMBLY INSTRUCTION

ZITA PLUS 19-0001 / 0002 / 0003 LIBERTY

A	B	C	D	E	F
					
24 PCS	16 PCS	4 PCS	4 PCS	4 PCS	1 PC
1	2	3	4	5	6
					
1 PC	4 PCS	2 PCS			

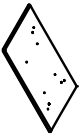
1

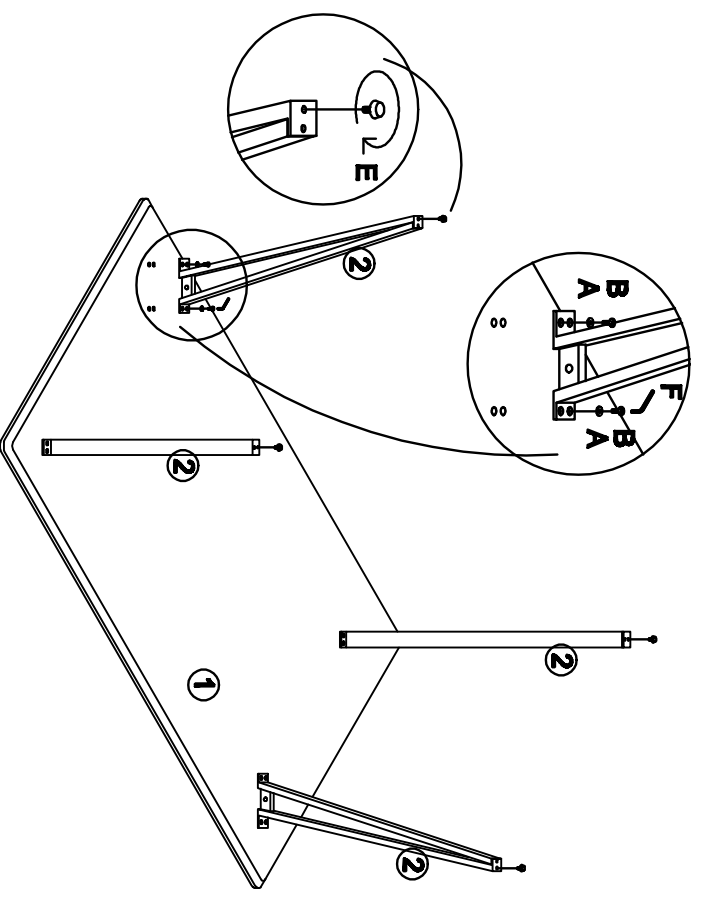

2

