

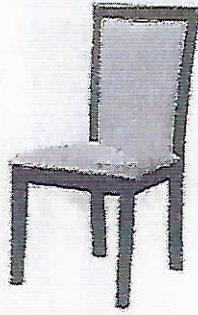









WARRANTY & ASSEMBLY GUIDE

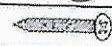

Read the instruction carefully, remove all the wrapping material, staples and straps from the carton. Refer to the hardware and furniture part list for guidance. Be sure that you have all the parts before you start assembling. Place all the wooden furniture part on a clean and flat soft surface, such as carpet or rubbermat to prevent from scratches.

HARDWARE LIST			
1	M6 X 45MM JCBC BOLT		6 PCS
2	M8 X 30MM WOODEN DOWEL		4 PCS
3	SPRING WASHER 1/4		6 PCS
4	M4 X 32MM C/B SCREW		3 PCS
5	ALLEN KEY		1 PC

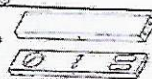
CAUTION
KEEP ALL THE PARTS OUT OF REACH OF CHILDREN

PART LIST			
A	BACK REST		1 PC
B	FRONT LEG		1 PC
C	SUPPORT BAR WRAP		2 PCS
D	CUSHION SEAT		1 PC

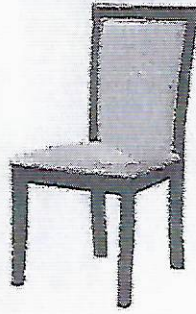

STEP 1:

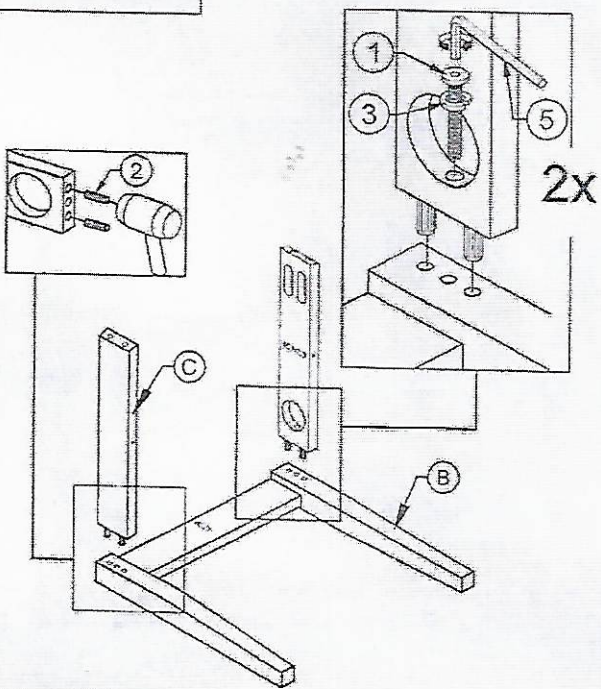

STEP 2:

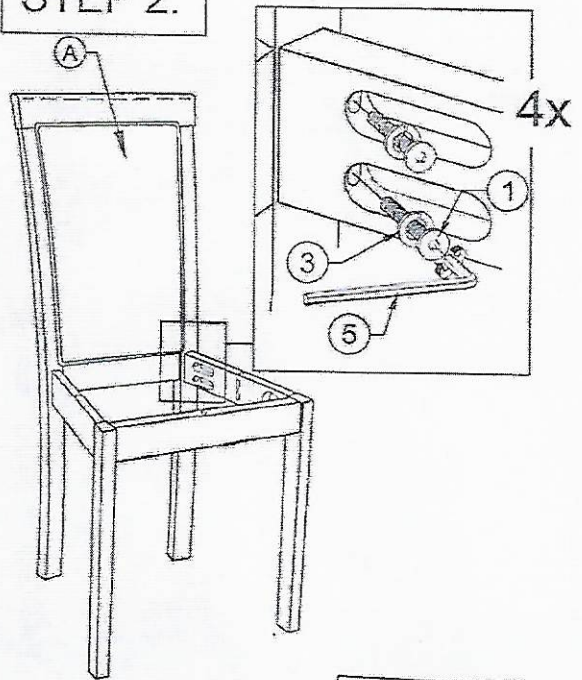

STEP 3:

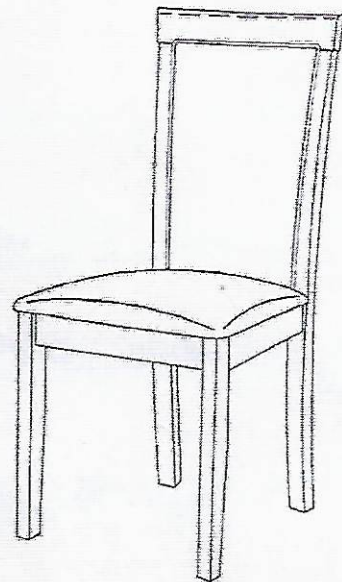
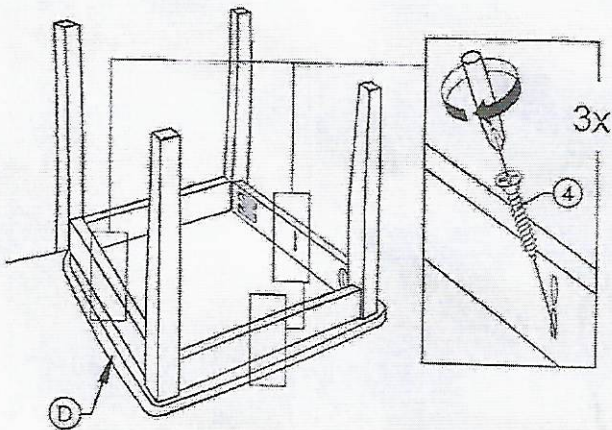



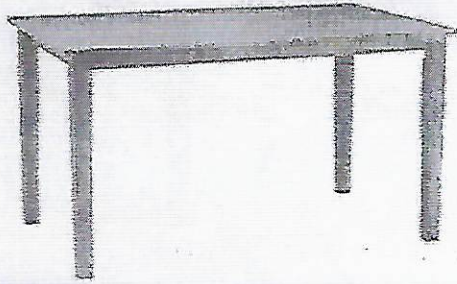

WARRANTY & ASSEMBLY GUIDE



Read instruction carefully. Remove all the wrapping materials, staples and straps from the carton. Refer to the hardware and furniture parts list as a guidance. Make sure you have all the parts before you start assembling. Place all the wooden furniture parts on a clean, flat and soft surface such as carpet to prevent from scratches.

CAUTION:

KEEP ALL HARDWARE PARTS OUT OF REACH CHILDREN.

HARDWARE LIST		
ITEM	DESCRIPTION	QTY
1	HEX COM SCREW 5/16" X 2 1/2" 	8 pcs
2	SPRING WASHER 5/16" 	8 pcs
3	FLAT WASHER 5/16" 	8 pcs
4	SPANNER 12.8 	1 pc

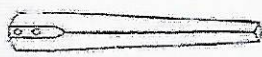
PARTS LIST		
ITEM	DESCRIPTION	QTY
A	TABLE TOP 	1 pc
B	TABLE LEG 	4 pcs

WARRANTY & ASSEMBLY GUIDE

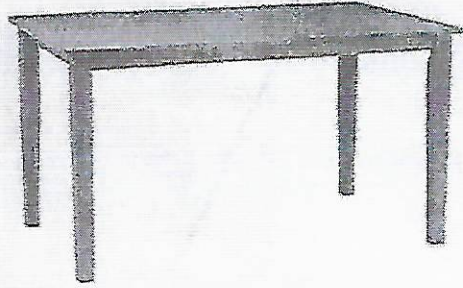

STEP 1

