

CASE

KİTAPLIK
BOOKCASE

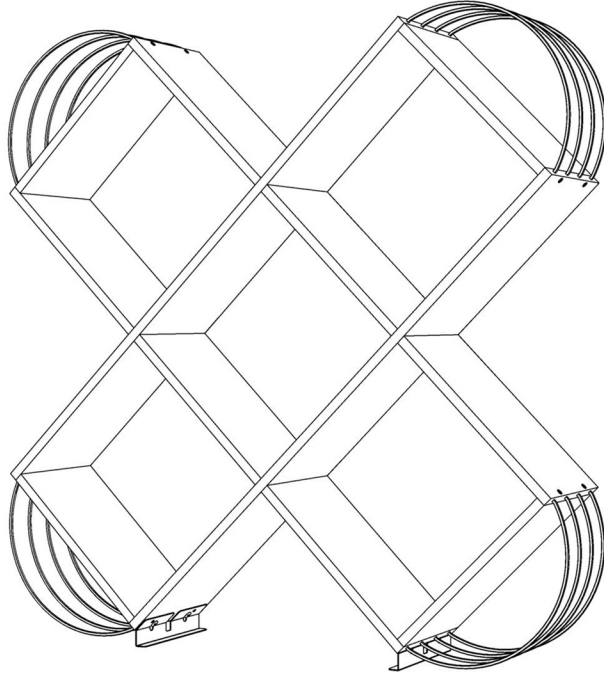

Kurulum Kılavuzu / Assembly Instructions



rafevi

www.rafevi.com

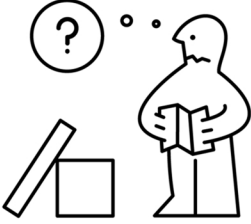
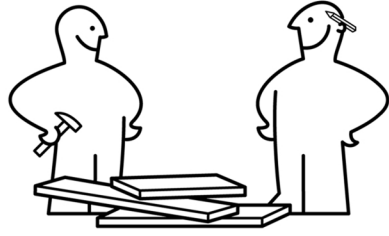
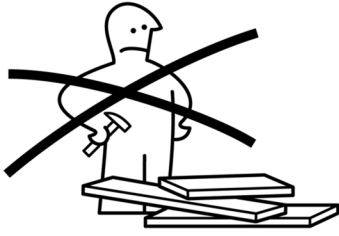

a
x41



b
x9

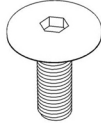

c
x5

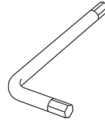

d
x2



e
x4

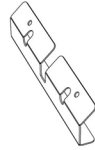

f
x2

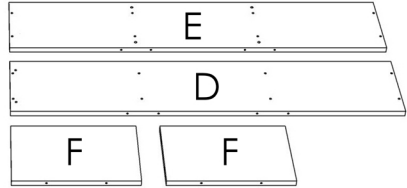
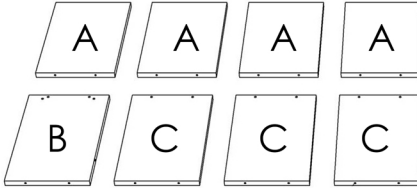

Bu ürünün kurulum videosuna Facebook sayfamızı beğenerek ulaşabilirsiniz.



You can access to the set-up video of this product when you like our facebook page.



www.facebook.com/rafevicom

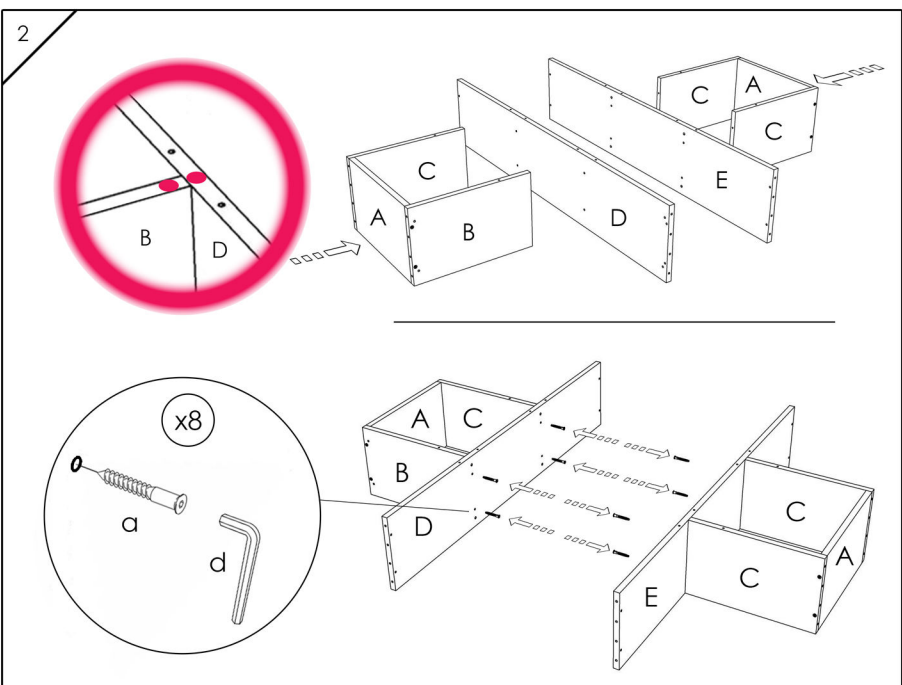
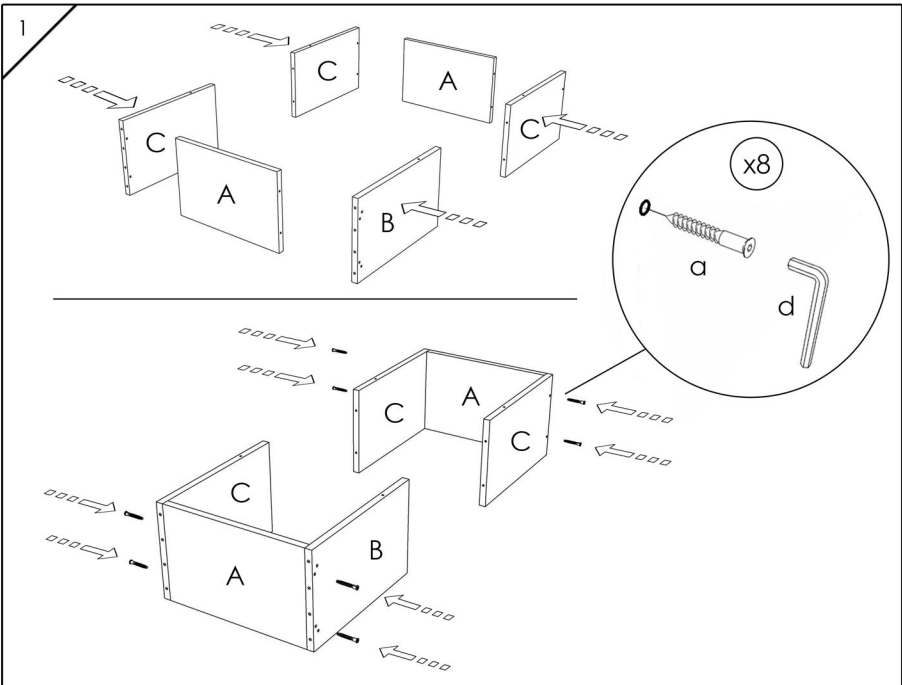

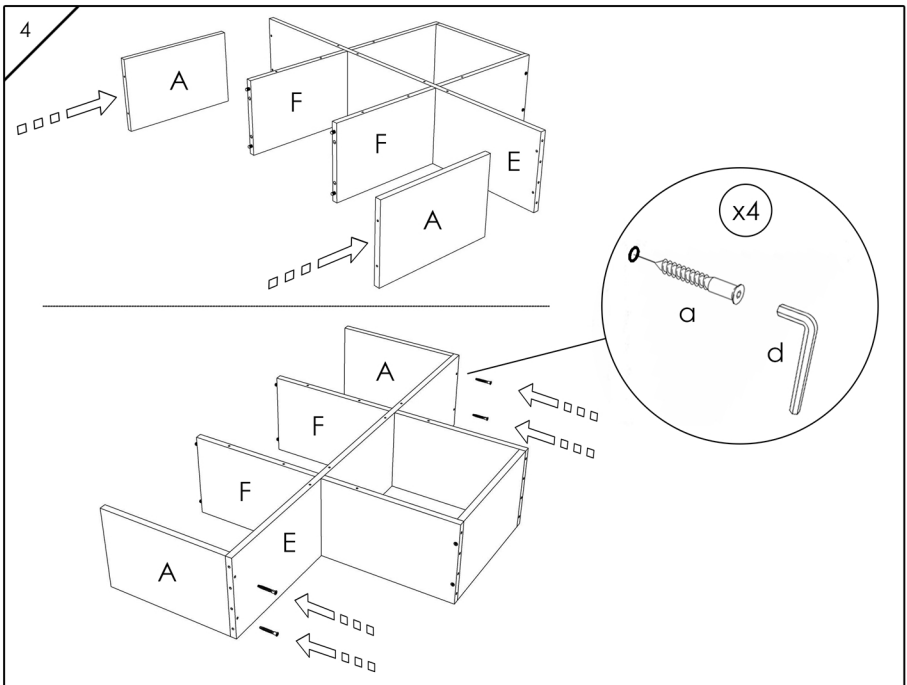
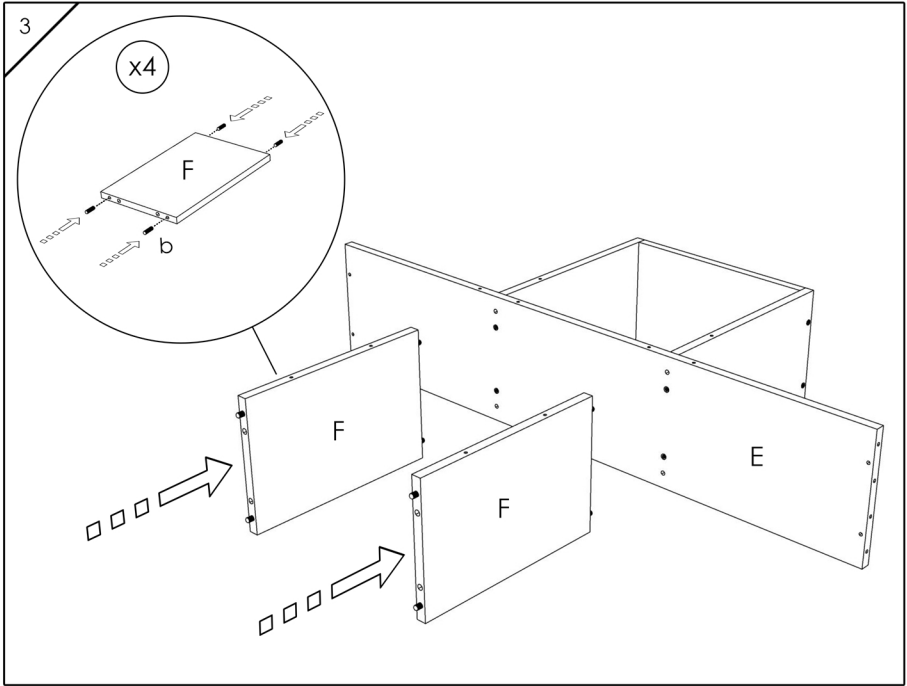

5

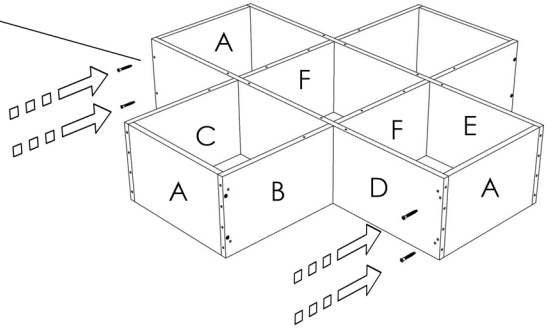
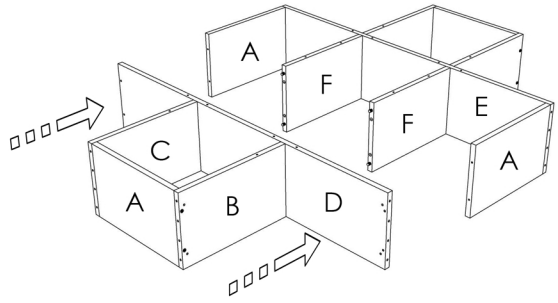
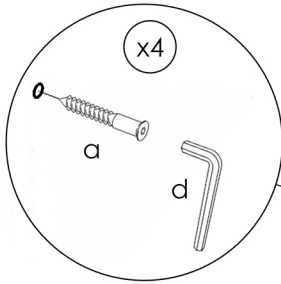

6

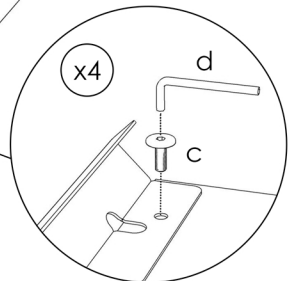
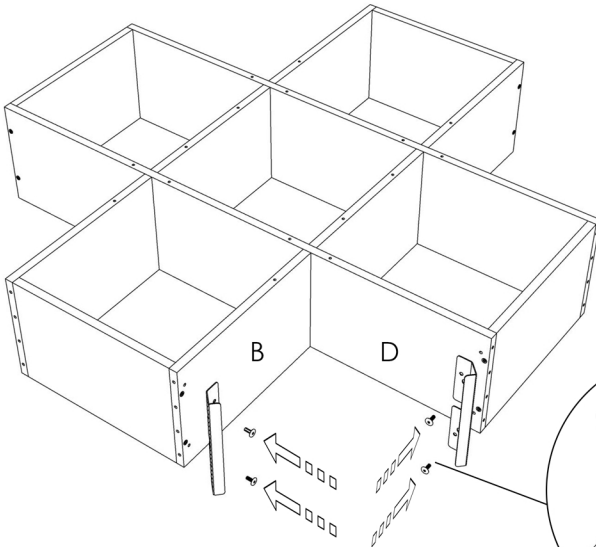

7

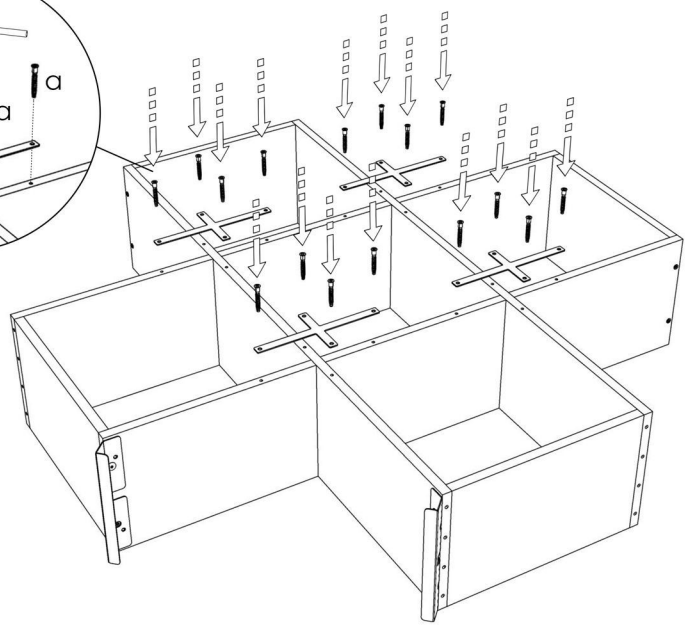
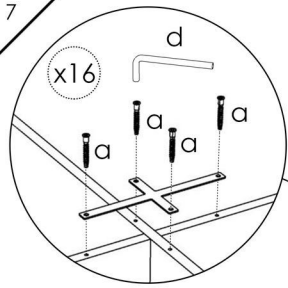

8

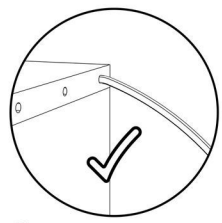
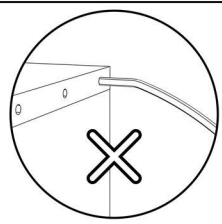
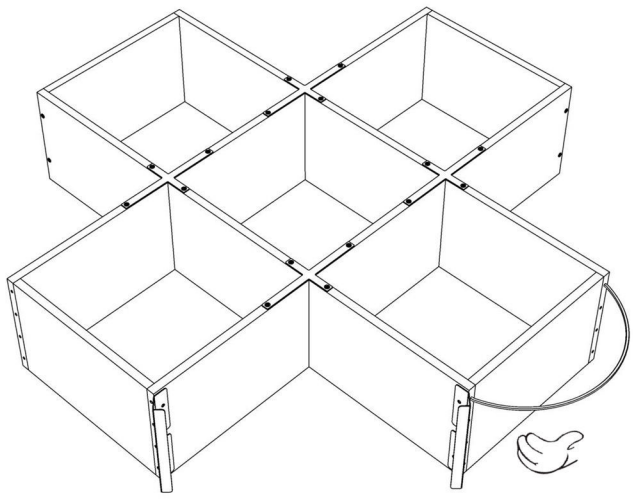

9

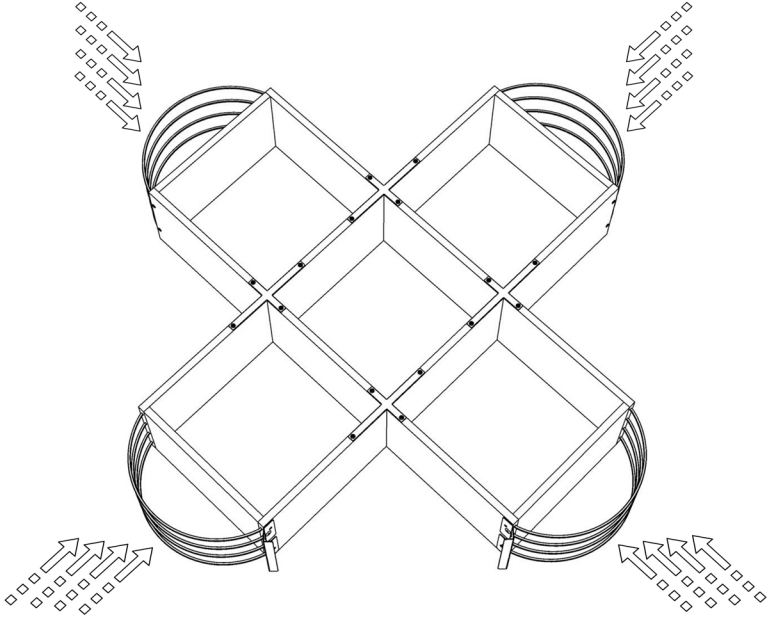

10

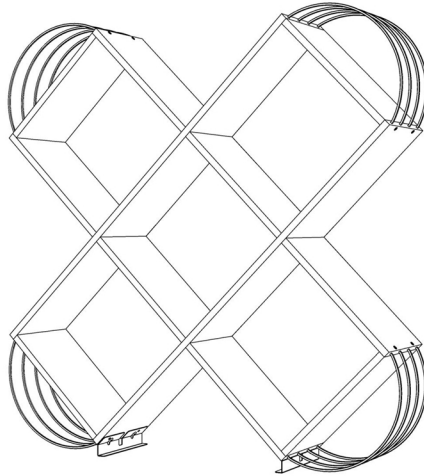

Case Kitaplık kullanıma hazır. Ürününüzün fotoğrafını sevdiklerinizle paylaşmak ister misiniz? **#rafevi #case**

Case Bookcase is ready to use. Would you like to share a photo with your friends?
#rafevi #case

Case Ailesinin diğr üyelerini denediniz mi?

Have you tried our other Case Family Products?

