

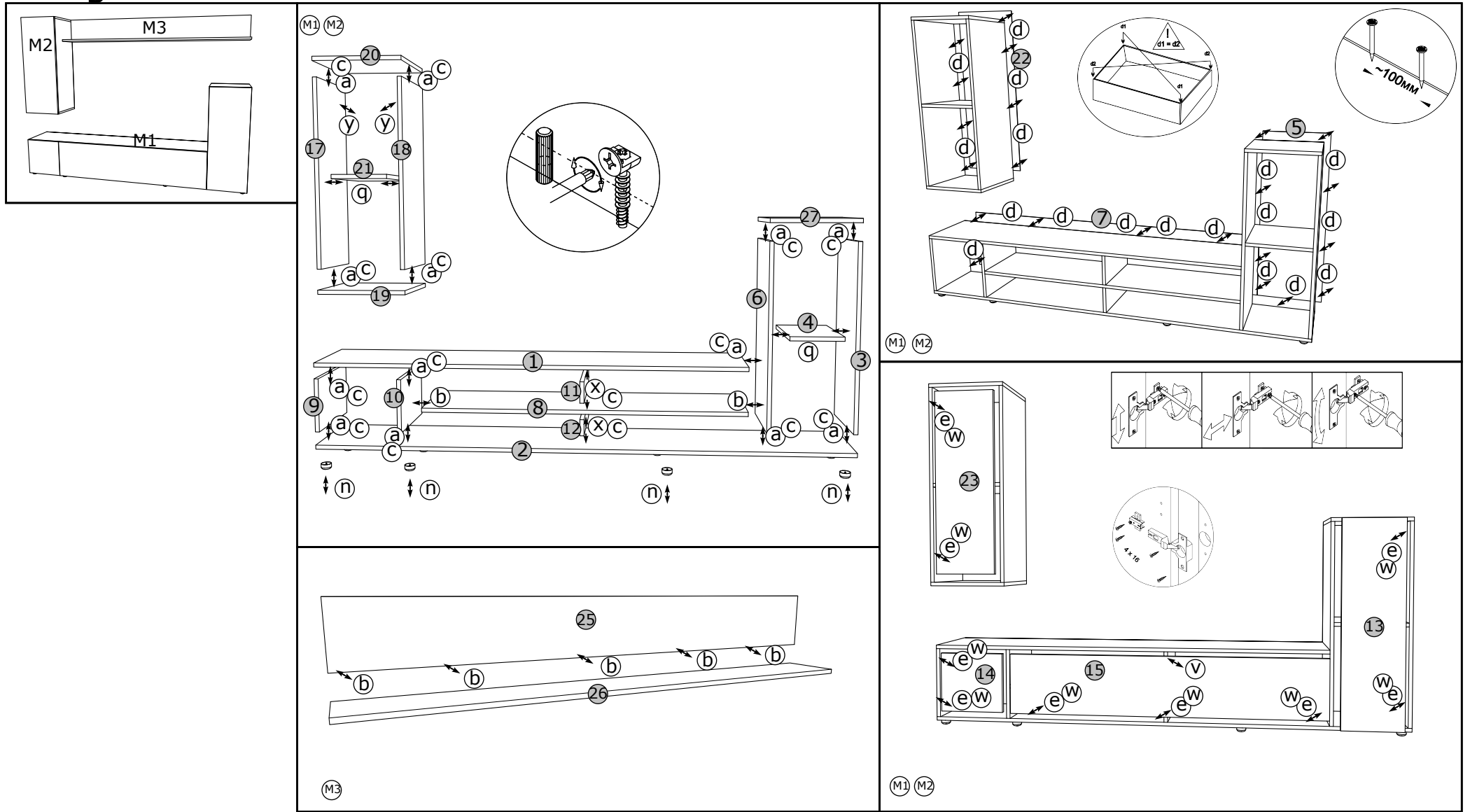

Bridge

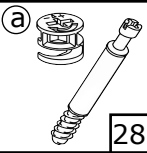
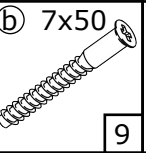
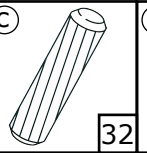
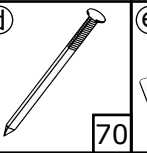
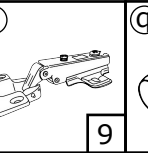
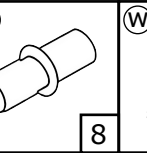
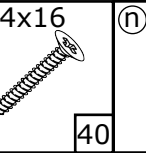
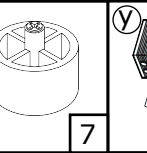
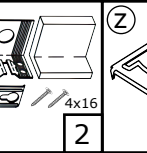
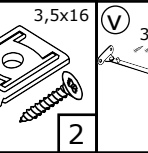
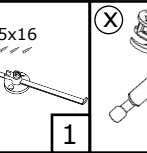
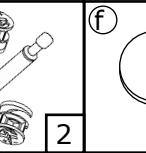

- | | | | | | | | | | | | | |
|-----------------------------------------------------------------------------------------|-----------------------------------------------------------------------------------------------|------------------------------------------------------------------------------------------|------------------------------------------------------------------------------------------|------------------------------------------------------------------------------------------|-------------------------------------------------------------------------------------------|-------------------------------------------------------------------------------------------------|--------------------------------------------------------------------------------------------|--------------------------------------------------------------------------------------------|---------------------------------------------------------------------------------------------------|---------------------------------------------------------------------------------------------------|--------------------------------------------------------------------------------------------|--------------------------------------------------------------------------------------------|
| 
a | 
b 7x50 | 
c | 
d | 
e | 
q | 
w 4x16 | 
n | 
y | 
z 3,5x16 | 
v 3,5x16 | 
x | 
f |
| 28 | 9 | 32 | 70 | 9 | 8 | 40 | 7 | 2 | 2 | 1 | 2 | 3 |