

# ASSEMBLY INSTRUCTIONS

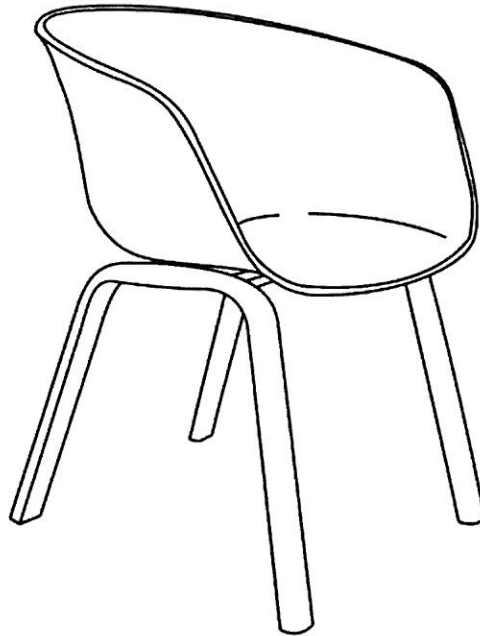

## IMPORTANT PLEASE READ BEFORE YOU CONTINUE FURTHER

THE PRODUCT YOU HAVE PURCHASED WILL GIVE YOU MANY YEARS OF SERVICE IF YOU FOLLOW THE GUIDELINES FOR ITS SAFE ASSEMBLY AND PERIODIC MAINTENANCE AND CLEANING.

DO NOT USE ANY TOOLS OTHER THAN THOSE SHOWN  
ANY SPANNERS OR ALLEN KEYS REQUIRED ARE INCLUDED WITH THE FITTINGS KIT.

DO NOT FOR ANY REASON USE A POWER TOOL TO ASSEMBLE THIS PRODUCT .ITS USE WILL INVALIDATE ANY CLAIM YOU MAY HAVE AND COULD MAKE THIS PRODUCT UNSAFE .

DEPENDING ON THE AMOUNT OF USE THIS PRODUCT RECEIVES IT MAY BE NECESSARY TO TIGHTEN UP THE FIXINGS FROM TIME TO TIME .THIS IS COMPLETELY NORMAL FOR ANY FLAT PACK FURNITURE



FOR CLEANING USE A DAMP CLOTH (NOT WET), DRY DUSTER AND NORMAL FURNITURE POLISH.

---

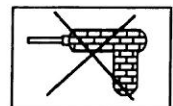
USE OF POWER TOOLS TO ASSEMBLE THIS PRODUCT WILL INVALIDATE ANY CLAIM AND MAY DAMAGE THIS PRODUCT MAKING IT UNSAFE.



# HARDWARE LIST

REF		HARDWARE NAME	QTY
A		M6 x 55 Bolt	4
B		M6 Washer	4
C			4

## PART LIST

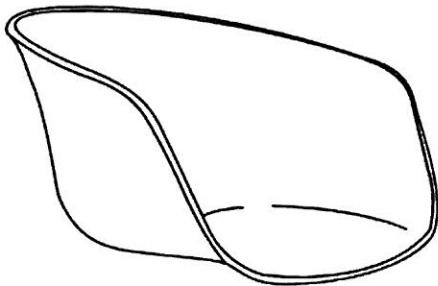

PLEASTIC SEAT: 1 PC

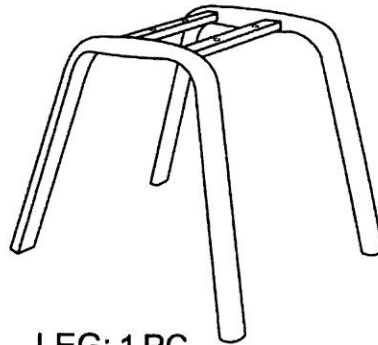

LEG: 1 PC

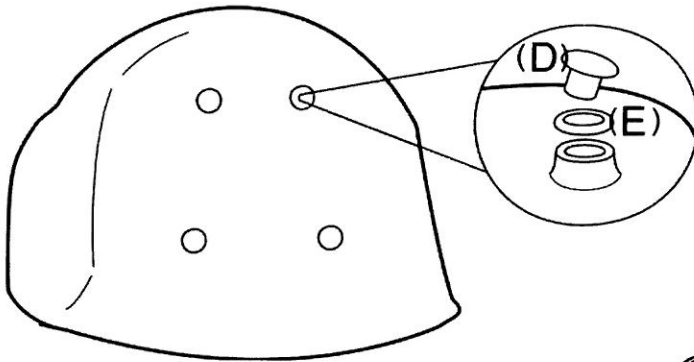

### STEP 1:

Remove the protective cover (D)

### STEP 2:

Assemble the plastic seat on the metal base by 4 pcs bolt(A) and 4 pcs washer (B) with 4 pcs plastic ring by allen key (C)

