

ASSEMBLY INSTRUCTION

MODEL : E 820,1

DESCRIPTION : 3 DRAWERS CHEST

HARDWARE	A	B	C	D	E	F	G	H	J	K	L
	WOOD DOWEL 8 X 25 8	CB SCREW M4X38MM 24	MINIFIX CAP 8	MINIFIX 5654+5546 8 SETS	CB SCREW M3.5X16MM 36	CB SCREW M4X25MM 12	MOON HANDLE 96MM (PVC) 6	NAIL 5/8 44	L KEY 1X1	DRAWER SLIDE 14" 4 SETS	WASHER 24

PART LIST

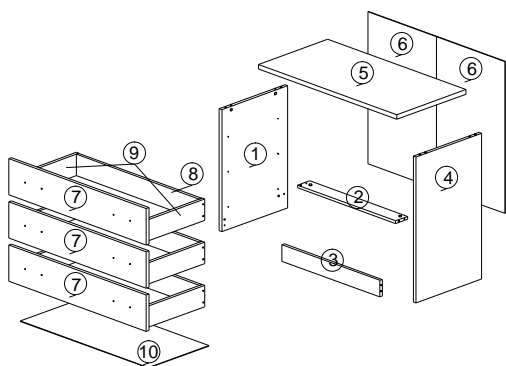

STEP 1

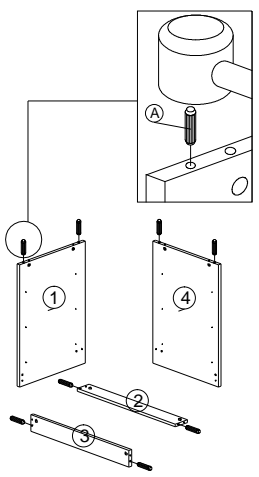

STEP 2

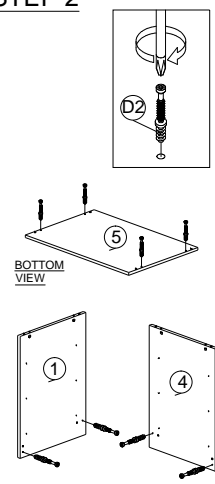

STEP 3

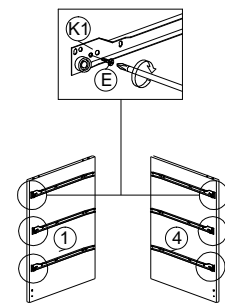

STEP 4

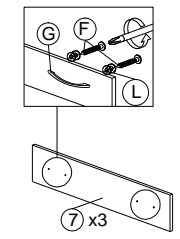

STEP 5

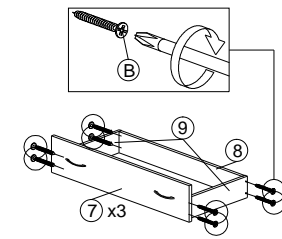

STEP 6

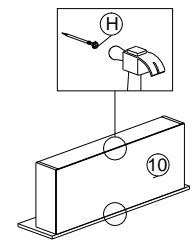

STEP 7

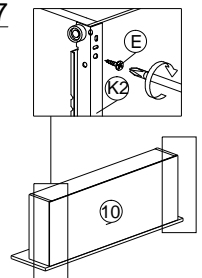

STEP 8

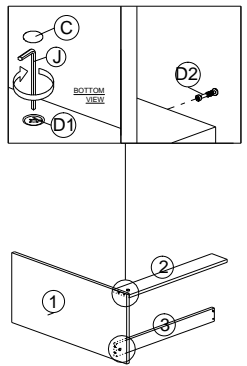

STEP 9

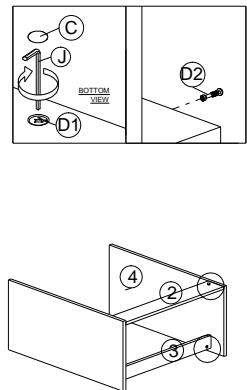

STEP 10

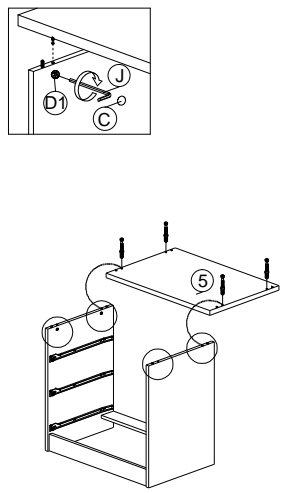

STEP 11

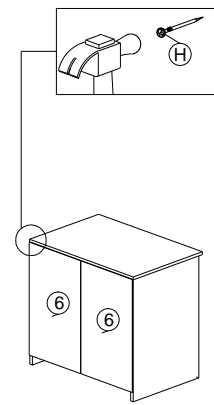

STEP 12

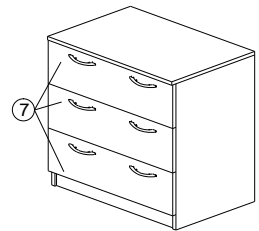

COMPLETED

