

# ASSEMBLE INSTRUCTION

\*\*\*DO NOT TIGHTEN SCREWS UNTIL COMPLETELY ASSEMBLED\*\*\*

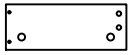

Ax2

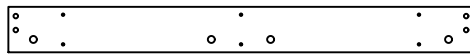

Bx2

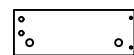

Cx2

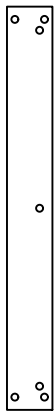

Dx5

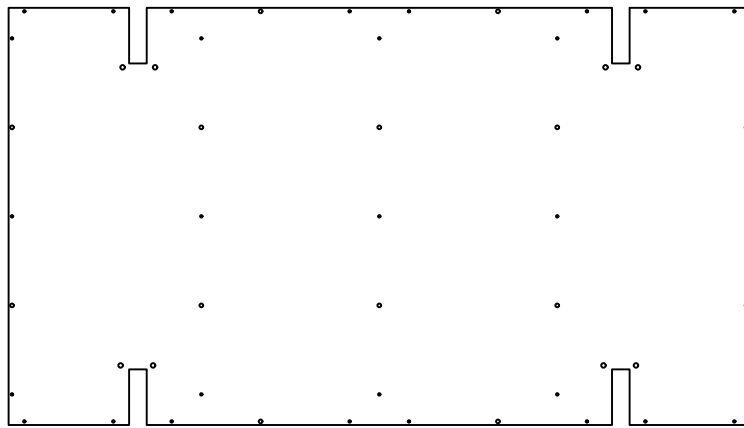

Ex1



ax51



bx51



cx14



M6 x 12

dx24



ex4

1

Ex 1  
ax31  
cx14

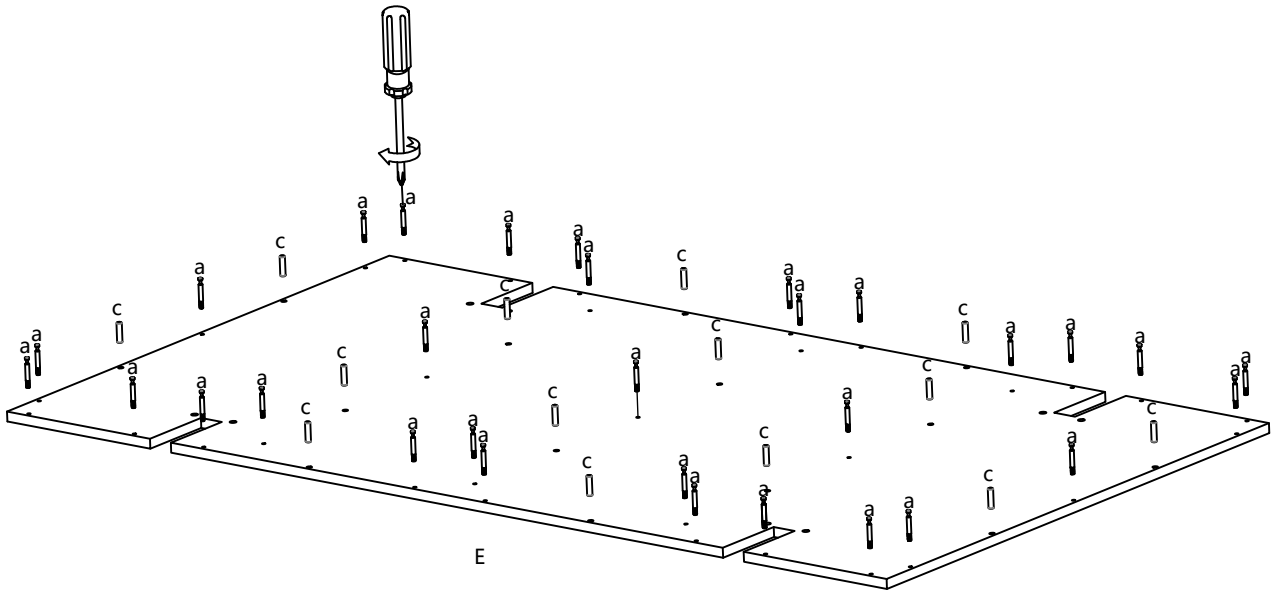

2

A x 2  
B x 2  
C x 2  
D x 5  
a x 20  
b x 20

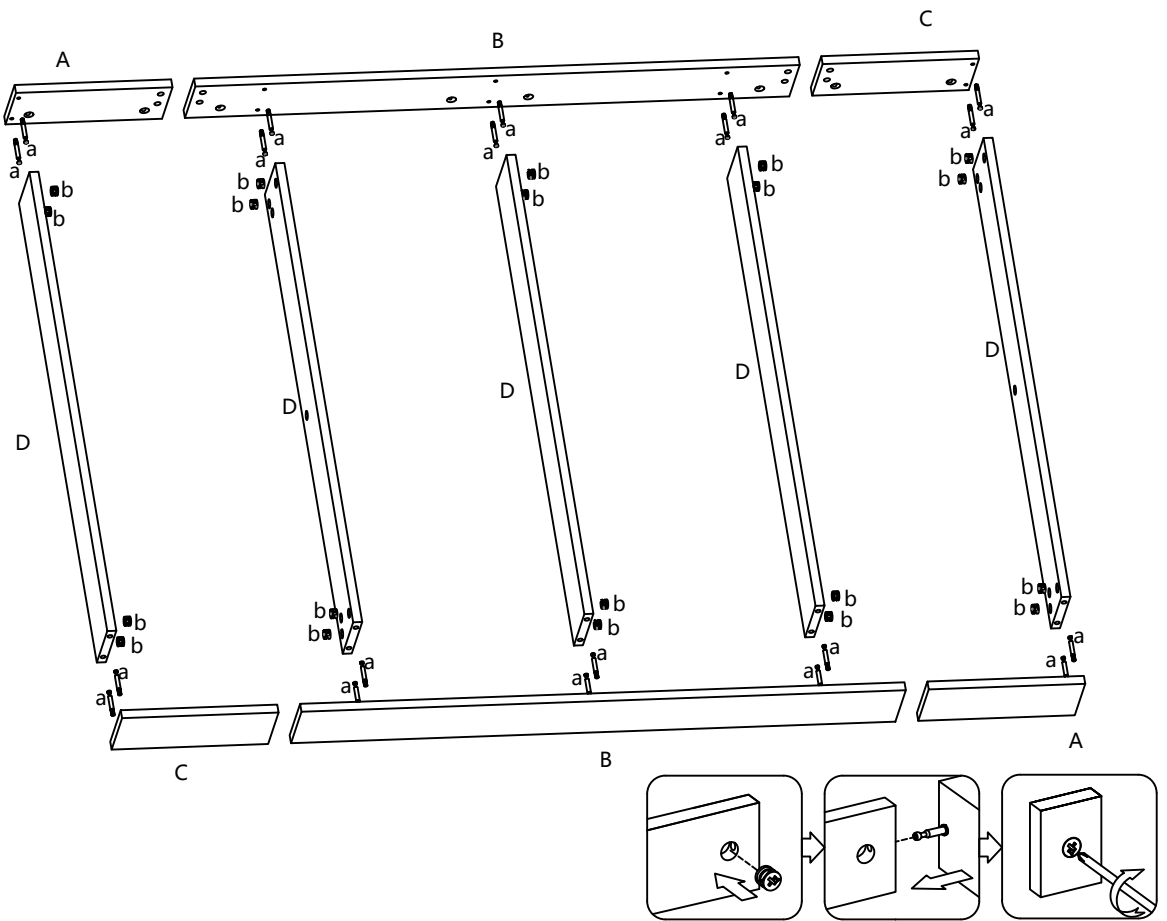

3

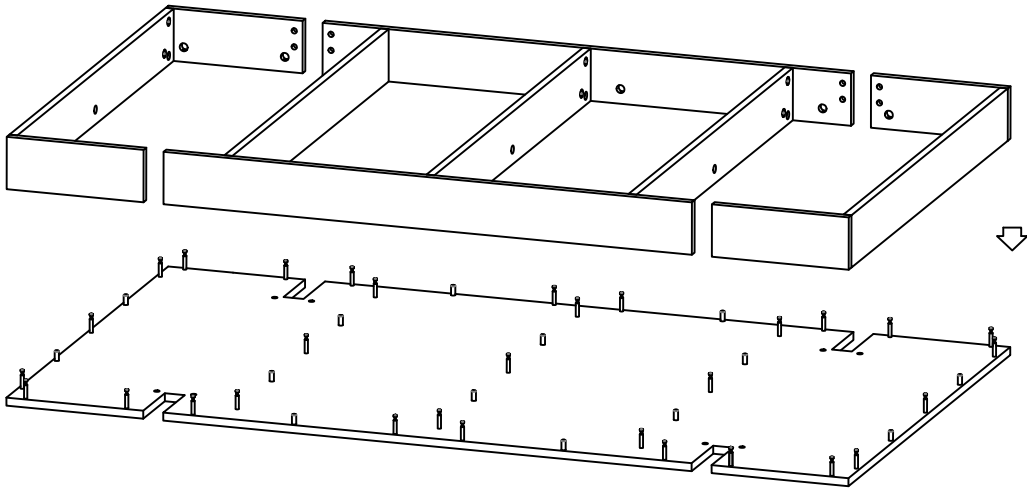

4

b x 31

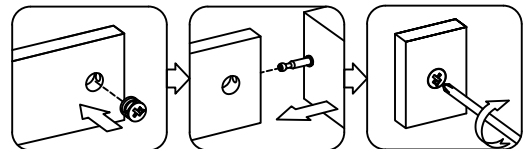
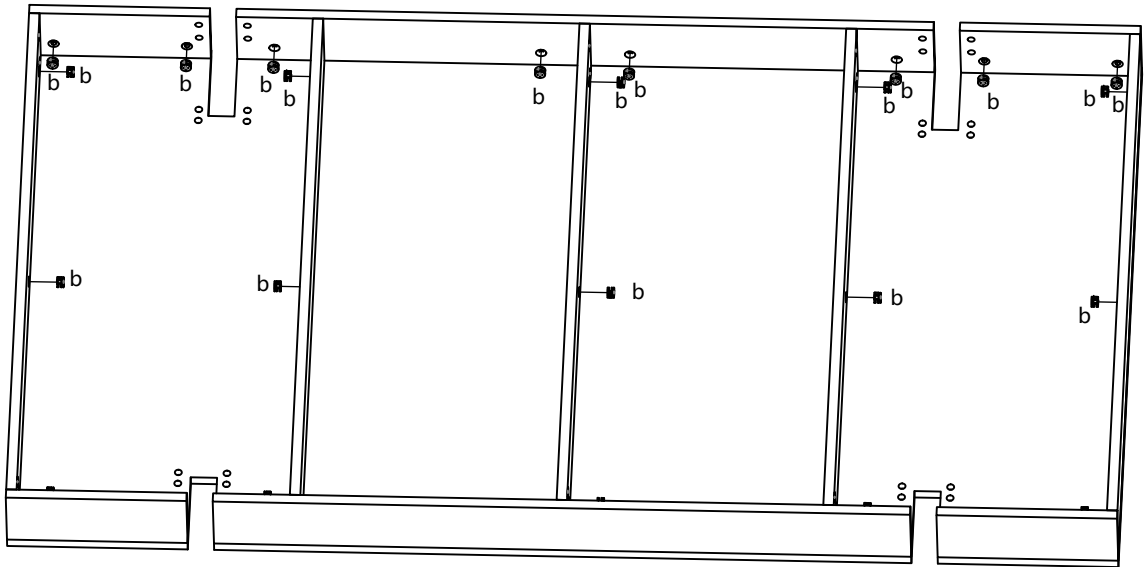

5

ex 4

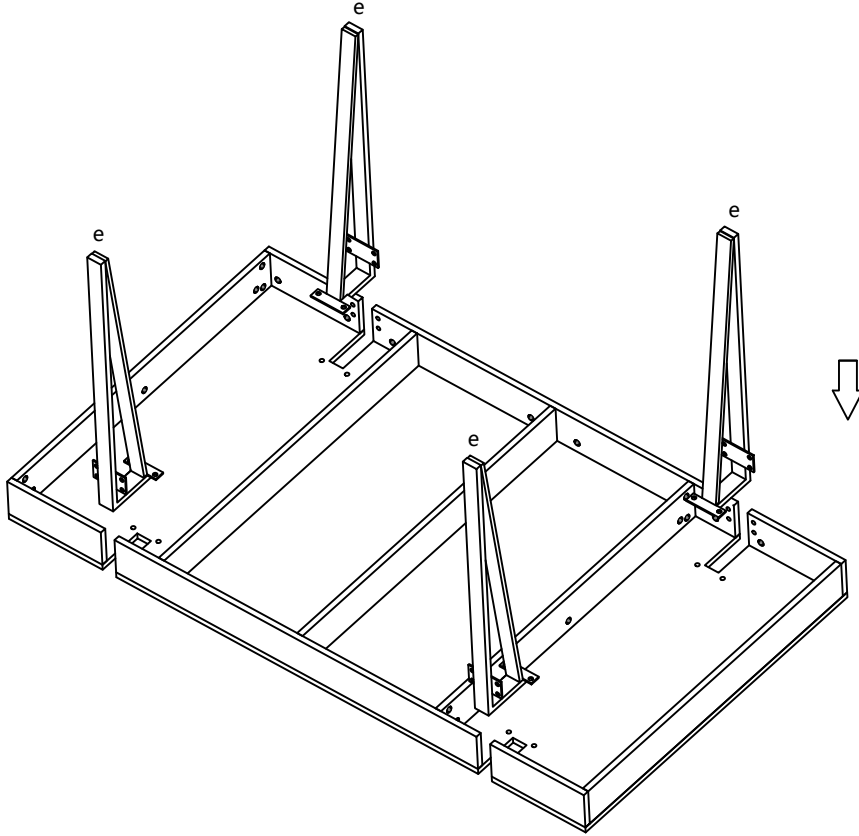

6

d x 24

